

LT131, 96011026401, 2008-01

---

# **SPARE PARTS LIST**

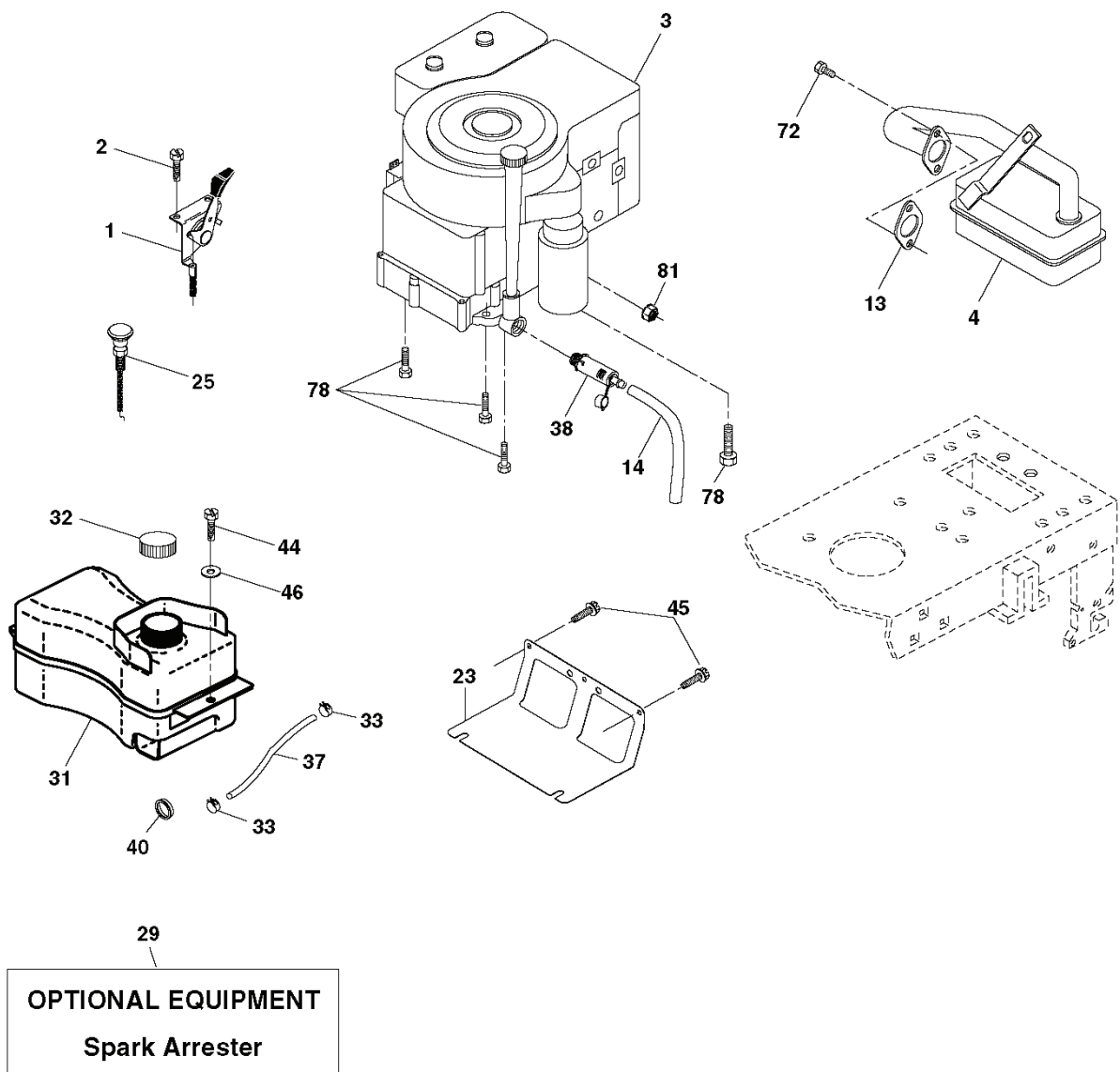

---

REF.	PART NO.	DESCRIPTION	REMARK	QTY.	KIT
1	532170551	THROTTLE CONTROL		1	
2	817720408	SCREW		1	
3				1	
4	532179758	MUFFLER		1	
13	532165291	GASKET		1	
14	532148456	TUBE		1	
23	532169837	HEAT SHIELD		1	
25	532190695	CONTROL CHOKE		1	
29	532137180	SPARK ARRESTER KIT		1	
31	532407516	FUEL TANK		1	
32	532197725	PLUG		1	
33	532123487	HOSE CLAMP		1	
37	532137040	HOSE		1	
38	532181654	PLUG		1	
40	532124028	BUSHING		1	
44	817670412	SCREW		1	
45	817000612	SCREW		1	
46	819091416	WASHER		1	
72	532192334	SCREW		1	
78	817060620	SCREW		1	
81	873510400	NUT		1	

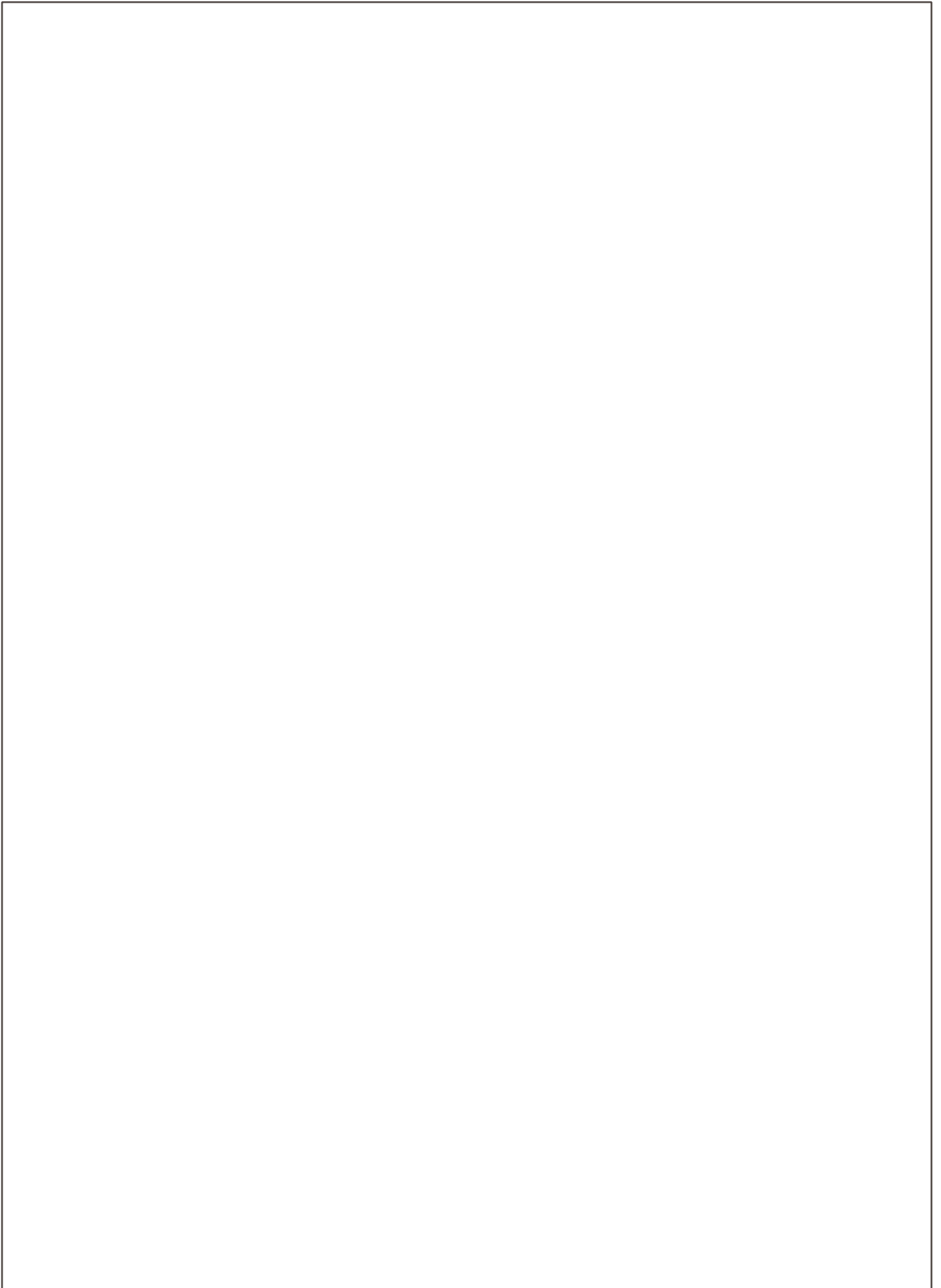

REF.	PART NO.	DESCRIPTION	REMARK	QTY.	KIT
1	532174619	FRAME		1	
2	532176554	PLATE		1	
5	532155272	DAMPER		1	
9	532415943	DASH		1	
10	872140608	BOLT		1	
11	532174996	DASHBOARD		1	
13	532181719	DASHBOARD		1	
14	817490608	SCREW		1	
17	532188893	HOOD		1	
18	532184921	BUMPER		1	
24	874780616	BOLT		1	
25	819131312	WASHER		1	
26	873800600	NUT		1	
28	532183538	GRILL		1	
30	532415833	FENDER		1	
31	532136619	ROD		1	
33	532179716	FOOTREST		1	
34	532179717	FOOTREST		1	
35	872110606	BOLT		1	
37	817490508	SCREW		1	
38	532175710	BRACKET		1	
39	532407807	BRACKET		1	
58	532184270	DUCT		1	
64	532154798	PANEL		1	
142	532175702	PLATE		1	
145	532409167	ROD		1	
206	532170165	BOLT		1	
207	817670508	SCREW		1	
208	817670608	SCREW		1	
209	817000612	SCREW		1	
212	532183548	INSERT		1	
258	532185214	LENS		1	
259	532185213	LENS		1	
260	532185216	INSERT		1	
261	532185212	INSERT		1	
272	532188896	VENT HOOD RH		1	
273	532188895	VENT HOOD LH		1	
278	532416358	SCREW		1	
--	532005479	PLUG	NOT SHOWN	1	

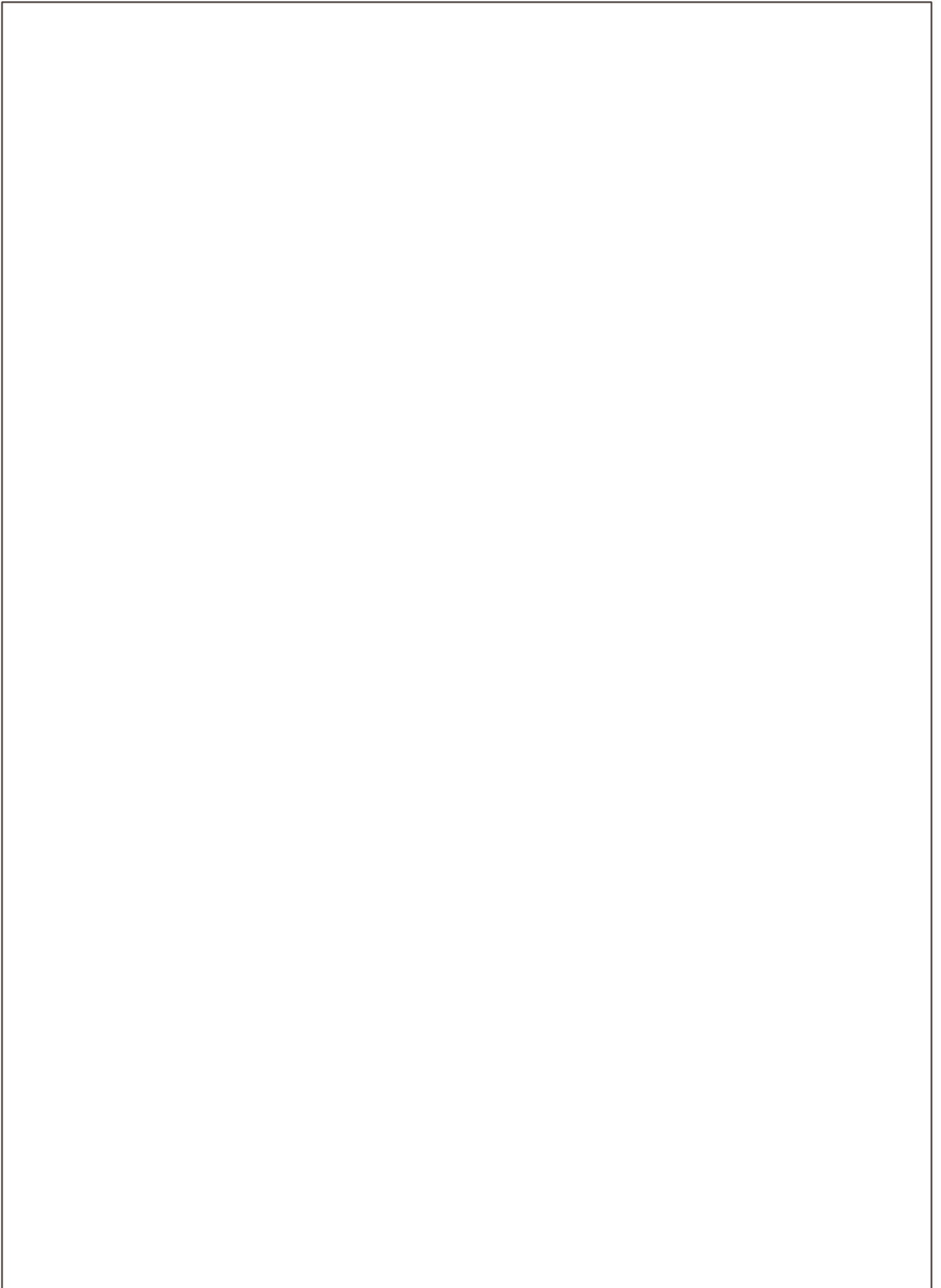

REF.	PART NO.	DESCRIPTION	REMARK	QTY.	KIT
1	532415558	DECAL		1	
2	532140837	DECAL		1	
3	532402832	LABEL		1	
4	532419019	DECAL		1	
5	532196841	DECAL		1	
6	532180432	DECAL		1	
7	532415550	DECAL		1	
8	532182166	DECAL		1	
9	532408813	DECAL		1	
10	532400389	LABEL		1	
11	532159736	DECAL		1	
12	532159737	DECAL		1	
13	532196357	DECALC."DANGER DEFLECTEUR"		1	
14	532194302	DECALC.SCHEMA MONTAGE		1	
20	532145005	DECAL		1	
--	532162598	DECAL	NOT SHOWN	1	
--	532138311	DECAL	NOT SHOWN	1	
--	532415514	OPERATOR'S MANUAL	NOT SHOWN	1	
--	532415515	OPERATOR'S MANUAL	NOT SHOWN	1	
--	532415516	OPERATOR'S MANUAL	NOT SHOWN	1	
--	532415517	OPERATOR'S MANUAL	NOT SHOWN	1	
--				1	



REF.	PART NO.	DESCRIPTION	REMARK	QTY.	KIT
1				1	
2	532146682	SPRING		1	
3	532123666	PULLEY		1	
4	812000028	CLIP		1	
5	532121520	BRACKET		1	
6	817060512	SCREW		1	
8	532192706	LEVER		1	
10	876020416	SPLIT PIN		1	
11	532105701	WASHER		1	
13	874550412	BOLT		1	
14	810040400	WASHER		1	
15	874490544	SCREW		1	
16	873800500	LOCK NUT		1	
18	874780616	BOLT		1	
19	873800600	NUT		1	
21	532106933	KNOB		1	
22	532130804	ROD		1	
24	873350600	NUT		1	
25	532106888	SPRING		1	
26	819131316	WASHER		1	
27	876020412	SPLIT PIN		1	
28	532175765	SHAFT		1	
29	532071673	COVER		1	
30	532174973	BRACKET		1	
32	874760512	BOLT		1	
34	532175578	SHAFT		1	
35	532120183	BEARING		1	
36	819211616	WASHER		1	
37	532124963	PIN RETAINING SCREW		1	
38	532179114	PULLEY		1	
39	872110622	BOLT		1	
41	532175556	BELT GUIDE		1	
47	532127783	PULLEY		1	
48	532154407	GUIDE		1	
49	532123205	BELT GUIDE		1	
50	872110612	BOLT		1	
51	873680600	NUT		1	
52	873680500	NUT		1	
53	532199652	TIGE DE TENSION POULIE		1	
55	532105709	SPRING		1	
56	817060620	SCREW		1	
57	532138255	BELT		1	
59	532169691	BELT GUIDE		1	
61	817120614	SCREW		1	
62	532124872	PEDAL RUBBER		1	
63	532175410	PULLEY		1	
64	532173937	BOLT		1	
65	810040700	WASHER		1	
66	532154778	TENSIONER		1	
69	532142432	SCREW		1	
70	532134683	BELT GUIDE		1	
74	532137057	SPACER		1	
75	532121749	WASHER		1	
76	812000001	RETAINER RING		1	
77	532123583	KEY		1	
78	532121748	WASHER		1	
79	532125096	WOODRUFF KEY		1	
80	532131486	ROD		1	
81	532165594	SHAFT		1	
82	532165711	SPRING		1	
83	819171216	WASHER		1	
84	532166228	LINK		1	
85	532150360	NUT		1	
89	532195861	CONSOLE		1	
96	532124788	RETAINER RING		1	
112	819091210	WASHER		1	
113	532127285	BRACKET		1	
116	872140608	BOLT		1	
120	873900600	NUT		1	
150	532175456	SPACER		1	
151	819133210	WASHER		1	
156	532166002	WASHER		1	
158	532165589	BRACKET		1	
159	532183900	LEVER		1	
161	872140406	BOLT		1	
162	873680400	NUT		1	
163	874780416	BOLT		1	
165	532165623	BRACKET		1	

---

REF.	PART NO.	DESCRIPTION	REMARK	QTY.	KIT
166	817490510	SCREW		1	
168	532165492	BOLT		1	
169	532165580	RETAINER		1	
170	532187414	KEEPER		1	
197	532169613	SLEEVE		1	
198	532169593	WASHER		1	
202	872110614	BOLT		1	
212	532145212	NUT		1	
263	817000612	SCREW		1	
268	532182402	PROTECTOR		1	
275	819131614	WASHER		1	

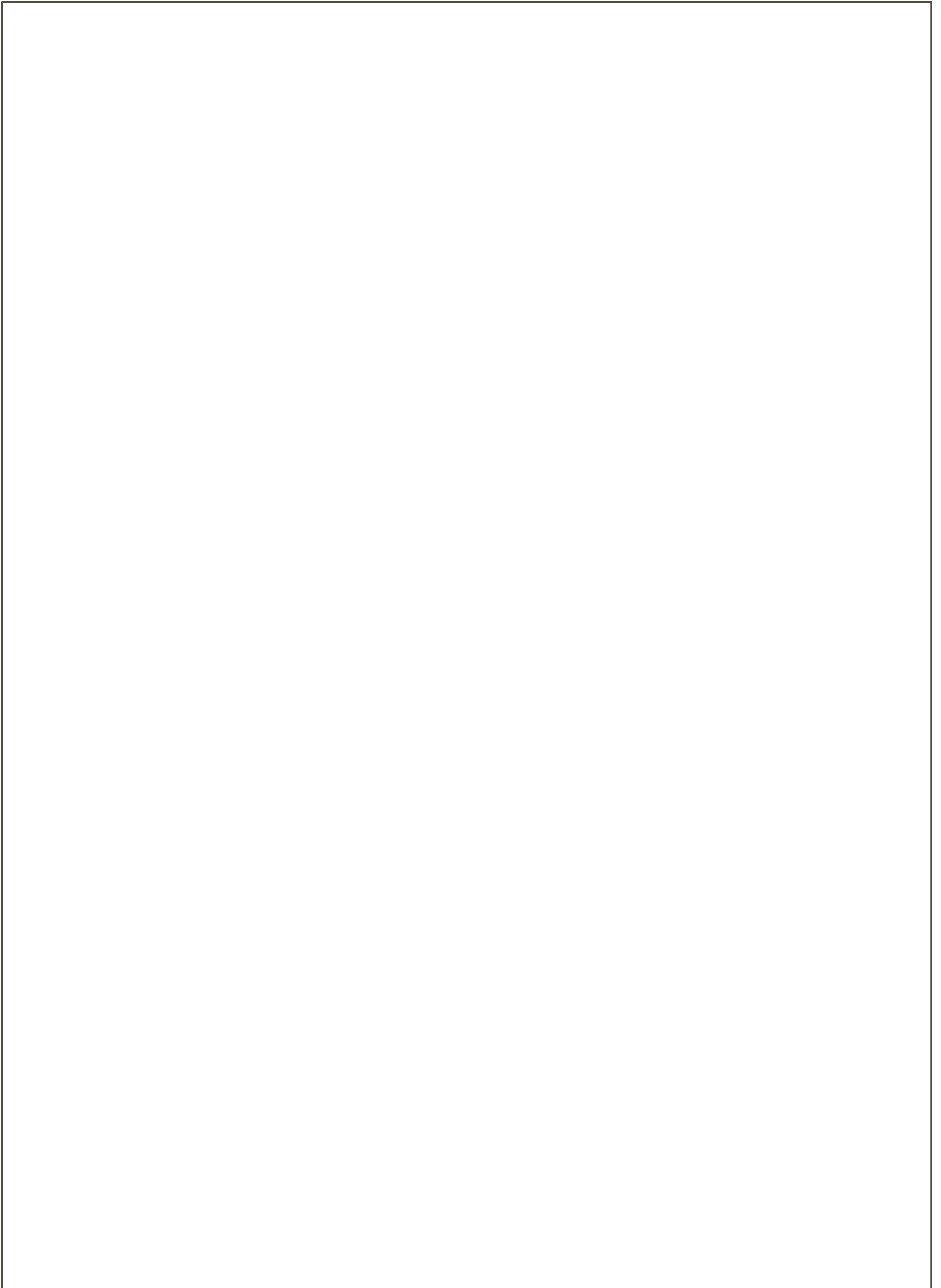

REF.	PART NO.	DESCRIPTION	REMARK	QTY.	KIT
1	532163465	BATTERY		1	
2	874760412	BOLT		1	
8	532176689	BATTERY BOX		1	
16	532176138	MICRO SWITCH		1	
21	532175688	HARNESS		1	
22	532004152	BULB		1	
24	532124780	CABLE		1	
25	532146147	CABLE		1	
26	532175158	FUSE		1	
27	873510400	NUT		1	
28	532124773	CABLE		1	
29	532192749	SWITCH.SEAT.DP W/RAMPS		1	
30	532193350	IGNITION MODULE		1	
33	532411935	KEY		1	
34	532110712	SWITCH		1	
40	532197428	CABLE ASSY		1	
41	871110408	BOLT		1	
42	532131563	COVER		1	
43	532192507	SOLENOID		1	
79	532175242	HOLDER		1	
90	532180449	COVER		1	
92	532196615	CABLE ASSY		1	
93	532192540	SCREW		1	
94	532191834	MODULE.REVERSE.ROS		1	

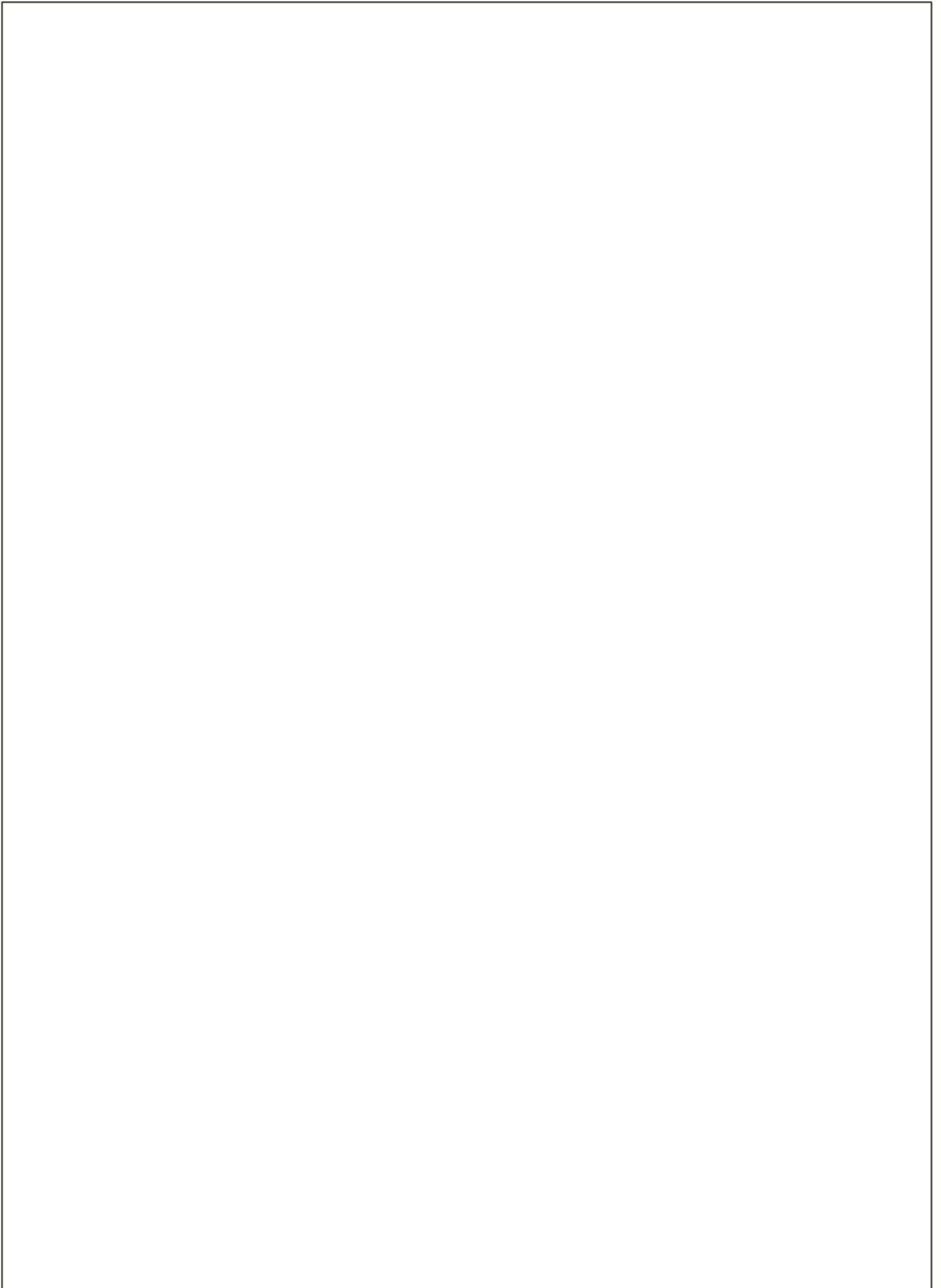

REF.	PART NO.	DESCRIPTION	REMARK	QTY.	KIT
1	532192556	DECK SHELL		1	
2	872140506	BOLT		1	
3	532138017	BRACKE		1	
4	532192568	SUPPORT CARTER ARRIERE		1	
5	532124670	RETAINER RING		1	
6	532178024	LEVER		1	
7	873800500	LOCK NUT		1	
8	532193003	SCREW		1	
11	532193957	RIDE ON BLADE		1	
13	532192872	SHAFT ASSY		1	
14	532187281	BEARING HOUSING		1	
15	532110485	BEARING		1	
18	872140505	BOLT		1	
19	532132827	SPEC. BOLT		1	
20	532400095	BAFFLE		1	
21	873680500	NUT		1	
23	532192557	HINGE		1	
24	532105304	HUB CAP		1	
25	532197026	TORSION SPRING		1	
26	532110452	NUT		1	
27	532401472	DEFLECTOR		1	
29	532131491	SHAFT		1	
30	532173984	SCREW		1	
31	532187690	WASHER		1	
32	532153532	PULLEY		1	
33	532400234	NUT		1	
36	532131494	PULLEY		1	
37	532193198	PULLEY		1	
40	873680600	NUT		1	
45	532124788	RETAINER RING		1	
55	532133840	LEVER		1	
56	532165723	SPACER		1	
67	532106932	KNOB		1	
68	532193214	BELT		1	
72	532193216	RESSORT RETOUR FREIN DE LAME		1	
89	819131311	WASHER		1	
107	532133502	SPACER		1	
108	532133503	LEVER		1	
122	532410189	ROD		1	
123	532410190	ROD		1	
144	532193414	BELT GUIDE		1	
148	532169022	SPRING		1	
149	532165898	SPRING		1	
150	819091210	WASHER		1	
152	532193235	CABLE		1	
158	817720408	SCREW		1	
185	532188234	CABLE		1	
186	817490644	SCREW		1	
187	532193412	BELT GUIDE		1	
188	532165891	BOLT		1	
189	532192559	SUPPORT BRAS DE FREIN		1	
190	532192560	ARM		1	
191	532192561	SPACER		1	
193	532193413	BELT GUIDE		1	
194	532194105	GARDE DE FREIN DE LAME		1	
195	819133210	WASHER		1	
214	532193782	BOLT		1	
--	532192558	FREIN DE LAME CPT.	NOT SHOWN	1	
--	532192870	SPINDLE	NOT SHOWN	1	
--	532193646	HOUSING	NOT SHOWN	1	

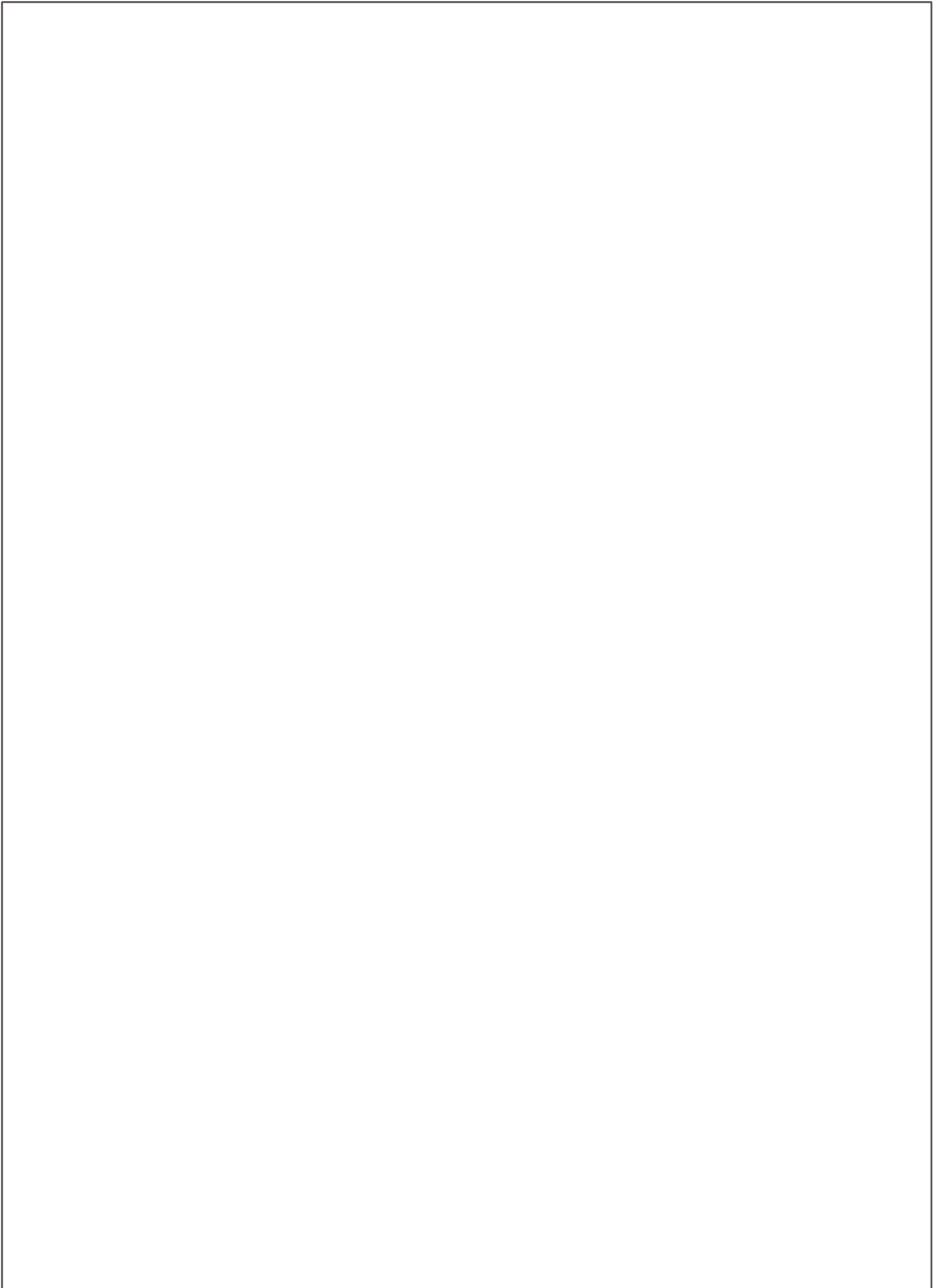

---

REF.	PART NO.	DESCRIPTION	REMARK	QTY.	KIT
1	532159460	WIRE		1	
2	532159471	LEVER		1	
3	532105767	PIN RETAINING SCREW		1	
4	812000002	RETAINER RING		1	
5	819211621	WASHER		1	
6	532120183	BEARING		1	
7	532109413	GRIP		1	
8	532124526	KNOB		1	
11	532139865	LINK		1	
12	532139866	LINK		1	
13	532124670	RETAINER RING		1	
15	532173288	LINK		1	
16	873350800	NUT		1	
17	532175689	BRACKET		1	
18	873800800	NUT		1	
19	532139868	LEVER		1	
20	532194209	SPRING		1	
31	532169865	BEARING		1	
32	873540600	NUT		1	
55	532194208	PIN		1	

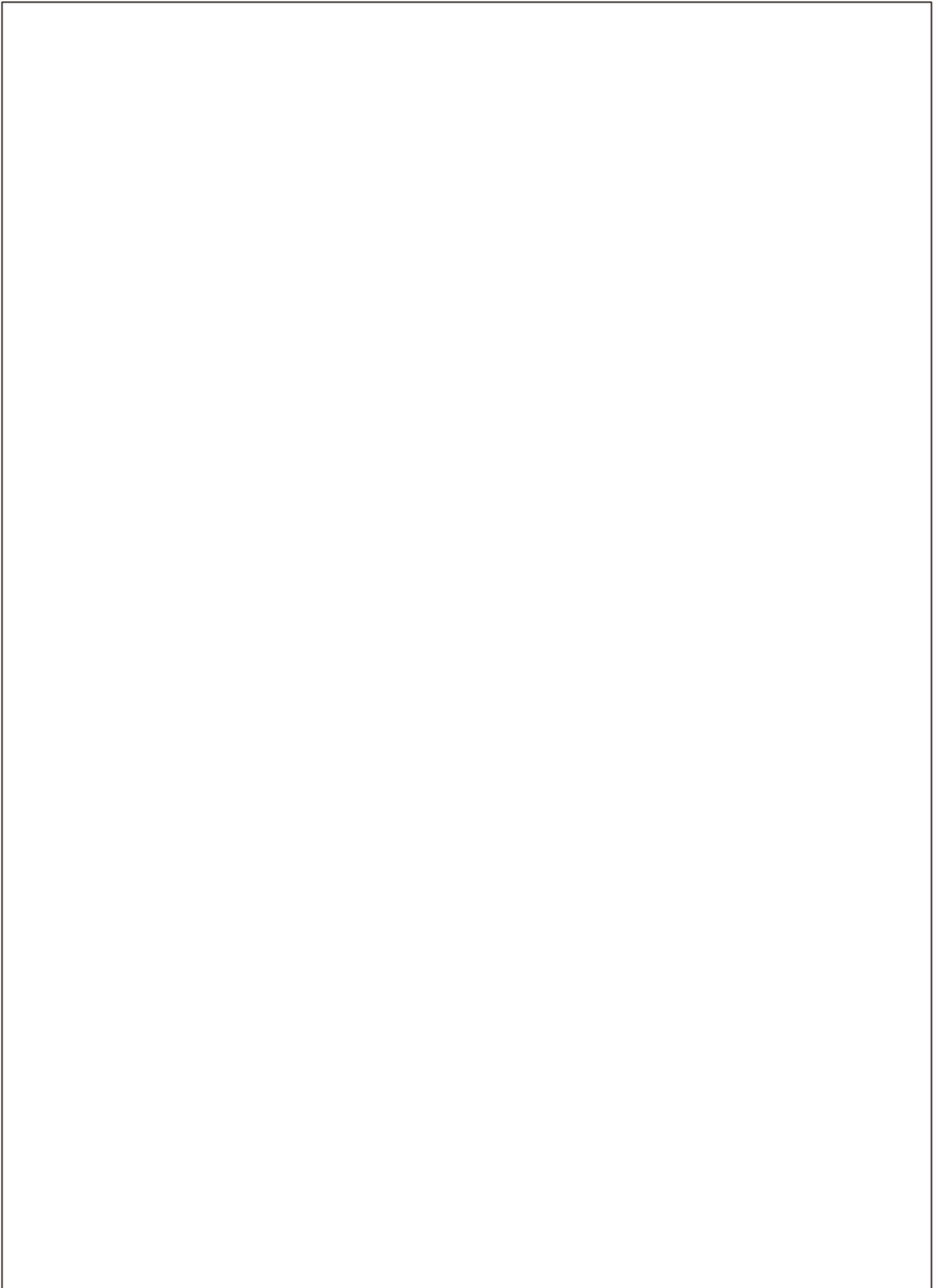



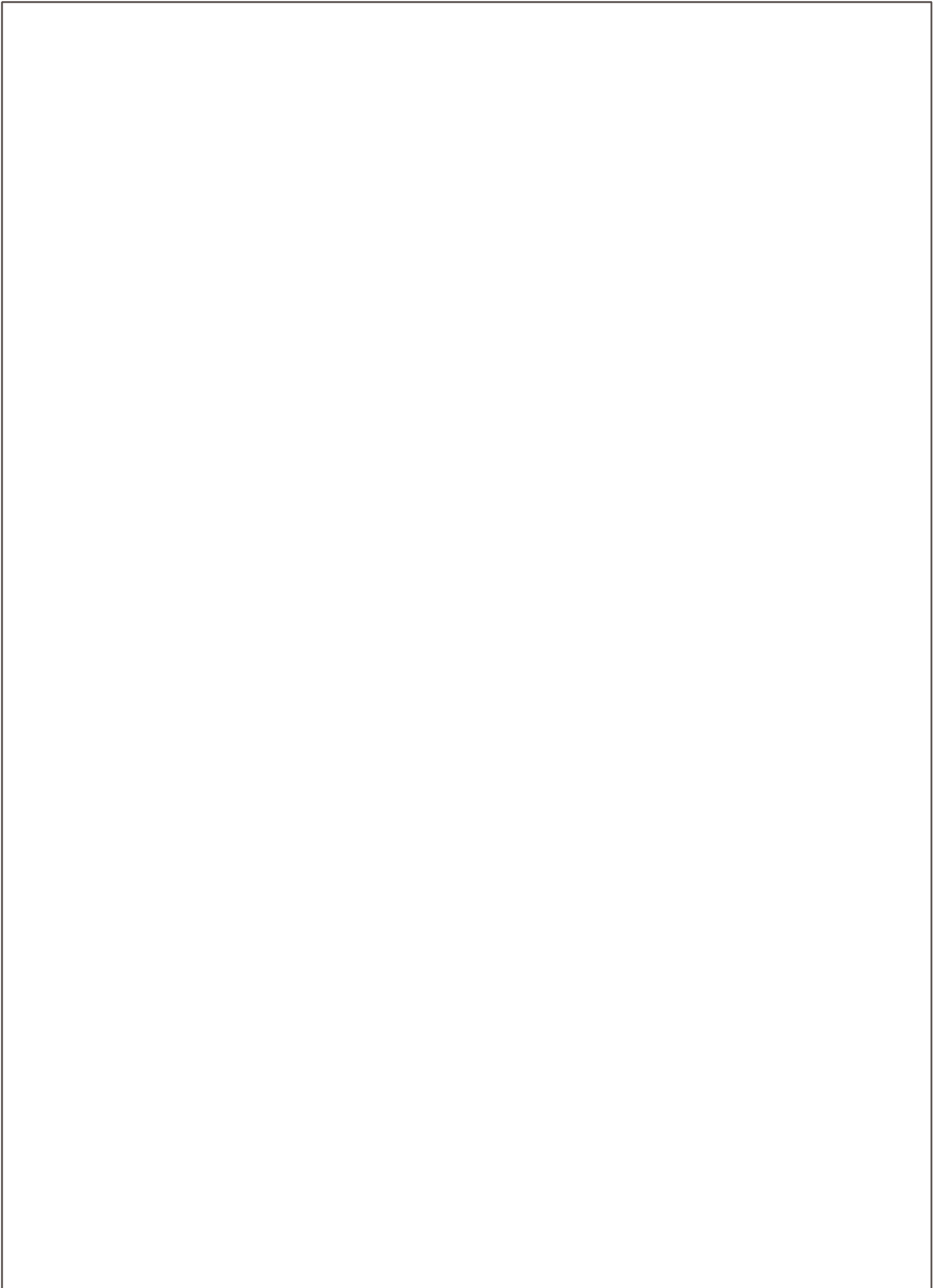

---

REF.	PART NO.	DESCRIPTION	REMARK	QTY.	KIT
1	532401042	SIEGE CONDUCTEUR		1	
2	532140551	BRACKET		1	
3	871110616	SCREW		1	
4	819131610	WASHER		1	
5	532145006	CLIP		1	
6	873800600	NUT		1	
7	532124181	SPRING		1	
8	817000616	SCREW		1	
9	819131614	WASHER		1	
10	532195530	BERCEAU DE SIEGE CONDUCTEUR		1	
12	532174648	BRACKET		1	
13	532121248	BUSHING		1	
14	872050412	BOLT		1	
15	532134300	SPACER		1	
16	532121250	SPRING		1	
17	532123976	LOCKNUT		1	
21	532171852	BOLT		1	
22	873800500	LOCK NUT		1	
23	871110814	BOLT		1	
24	819171912	WASHER		1	
25	532127018	BOLT		1	
26	810040800	WASHER		1	

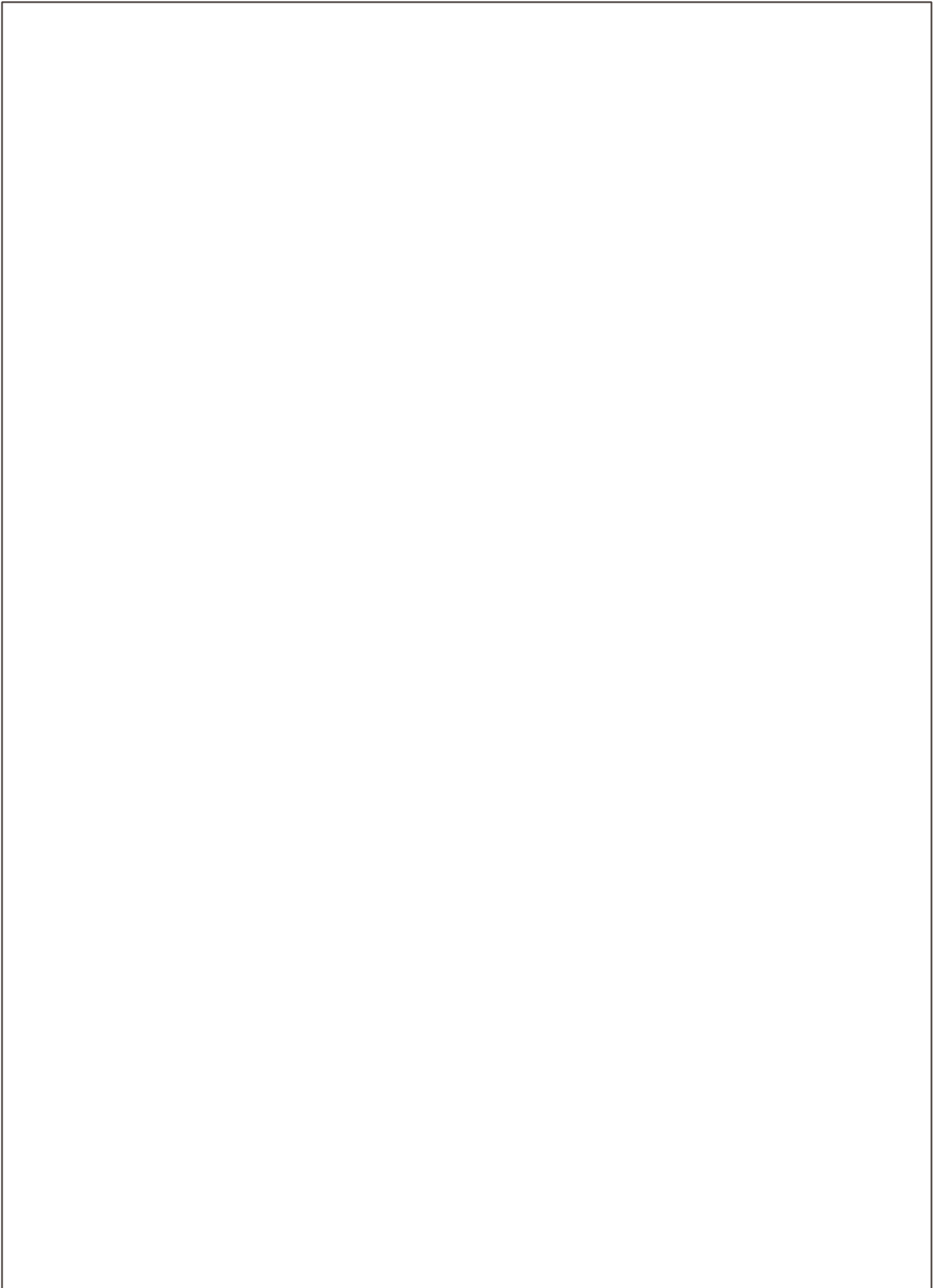

REF.	PART NO.	DESCRIPTION	REMARK	QTY.	KIT
1	532186780	STEERING WHEEL		1	
2	532418168	AXLE		1	
3	532169840	SPINDLE		1	
4	532169839	SPINDLE		1	
5	532124931	WASHER		1	
6	532121748	WASHER		1	
7	819272016	WASHER		1	
8	812000029	RETAINER RING		1	
9	532124937	BEARING COL. STRG.		1	
10	532175121	ROD		1	
11	810040600	WASHER		1	
13	532136518	PIPE		1	
15	532145212	NUT		1	
17	532190753	ROD		1	
26	532126847	BUSHING		1	
28	819131416	WASHER		1	
29	817000612	SCREW		1	
30	876020412	SPLIT PIN		1	
32	532192757	TIGE D'ASSEMBLAGE		1	
34	810040500	WASHER		1	
36	532155099	BUSHING		1	
37	532152927	SCREW		1	
38	532192916	INSERT DE VOLANT		1	
39	819113812	WASHER		1	
40	873540600	NUT		1	
41	532186737	ADAPTER		1	
42	532169633	SLEEVE		1	
43	532121749	WASHER		1	
44	532190752	SHAFT		1	
46	532121232	HUB CAP		1	
65	532414736	SPACER		1	
67	872110618	BOLT		1	
68	532169827	SHAFT		1	
71	532175146	STEERING GEAR		1	
82	532199978	SUPPORT ESSIEU AVANT		1	
88	532175118	BOLT		1	
91	532175553	SPRING		1	
95	532188967	WASHER		1	
97	874780564	BOLT		1	

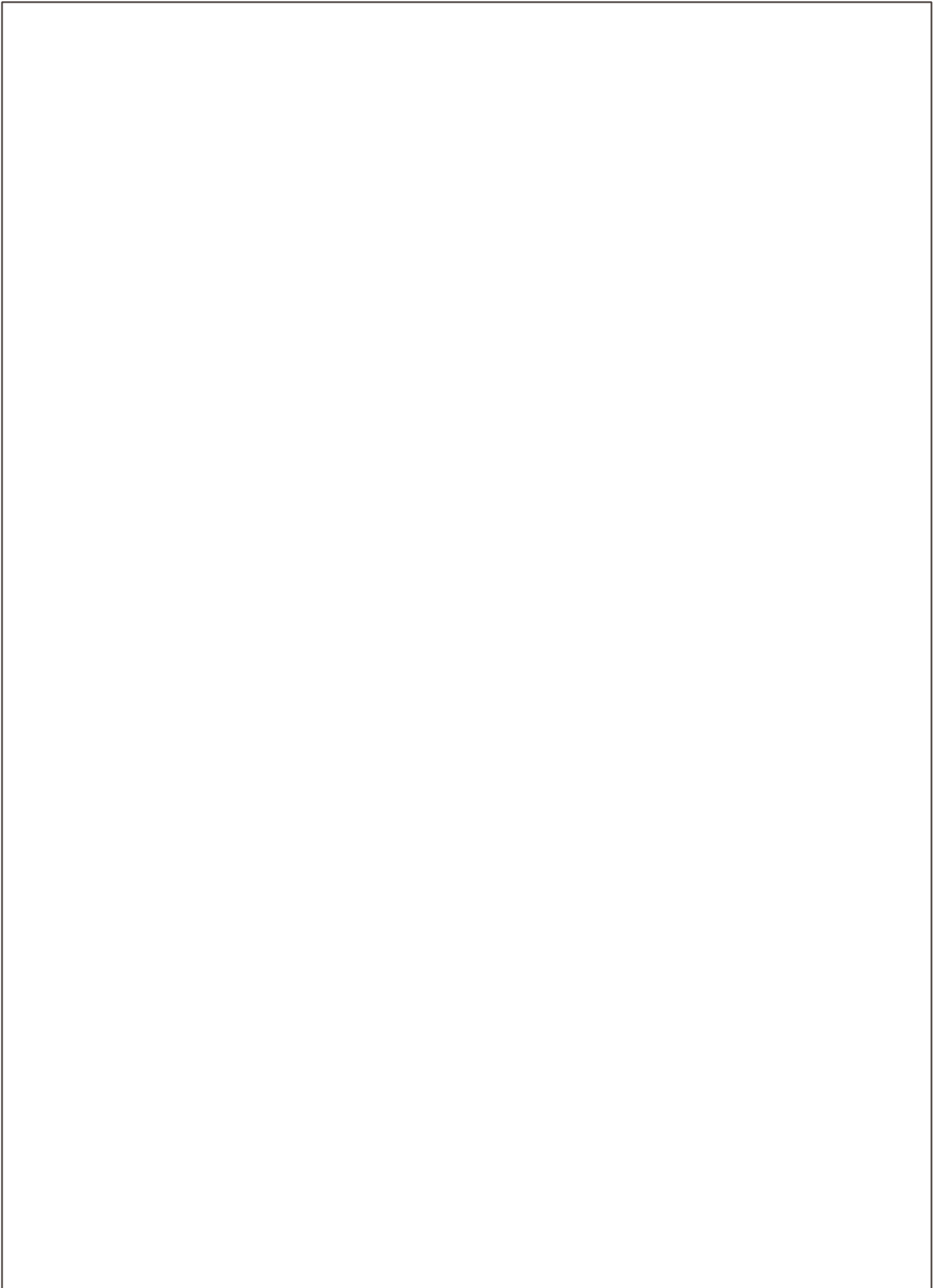

REF.	PART NO.	DESCRIPTION	REMARK	QTY.	KIT
1	532059192	CAP VALVE		1	
2	532065139	NIPPLE		1	
3	532124157	TIRE		1	
4	532059904	HOSE		1	
5	532138336	RIM		1	
6	532124957	FITTING		1	
7	532124959	BEARING		1	
8	532138337	RIM.SPROCKET		1	
9	532123969	TIRE		1	
10	532124926	HOSE		1	
11	532175039	HUB CAP		1	
--	532144334	SEALING FOAM		1	
	PART NO.		REMARK		KIT